

P/N:110401111507X

**UNI-T®**

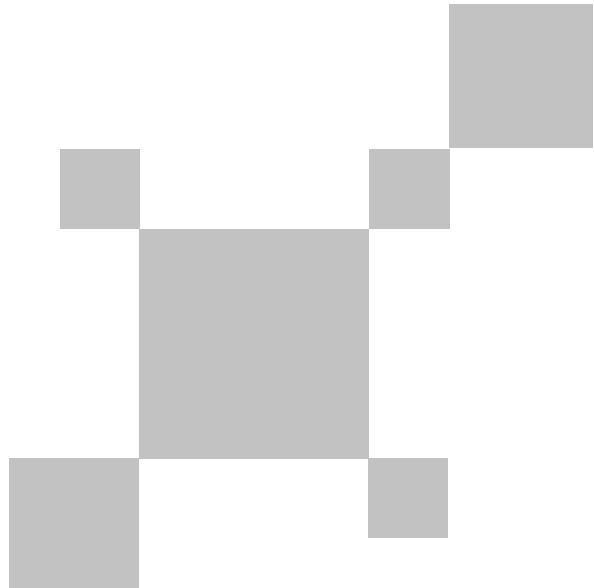

## **UT219P AC Digital Power Clamp Meter User Manual**

**UNI-T®**

**UNI-TREND TECHNOLOGY (CHINA) CO., LTD.**

No. 6, Gong Ye Bei 1st Road,  
Songshan Lake National High-Tech Industrial  
Development Zone, Dongguan City,  
Guangdong Province, China

### **Preface**

Thank you for purchasing this brand new product. In order to use this product safely and correctly, please read this manual thoroughly, especially the safety notes.

After reading this manual, it is recommended to keep the manual at an easily accessible place, preferably close to the device, for future reference.

### **Limited Warranty and Liability**

Uni-Trend guarantees that the product is free from any defect in material and workmanship within one year from the purchase date. This warranty does not apply to damages caused by accident, negligence, misuse, modification, contamination or improper handling. The dealer shall not be entitled to give any other warranty on behalf of Uni-Trend. If you need warranty service within the warranty period, please contact your seller directly.

Uni-Trend will not be responsible for any special, indirect, incidental or subsequent damage or loss caused by using this device.

## Contents

|  |    |
|--|----|
| I. Overview                            | 4  |
| II. Features                           | 4  |
| III. Accessories                       | 5  |
| IV. Safety Information                 | 5  |
| V. Electrical Symbols                  | 6  |
| VI. General Specifications             | 6  |
| VII. External Structure and Test Leads | 7  |
| VIII. LCD Display                      | 8  |
| IX. Rotary Switch                      | 9  |
| X. Button Descriptions                 | 9  |
| XI. Operating Instructions             | 9  |
| XII. Technical Specifications          | 27 |
| XIII. Bluetooth Software               | 31 |
| XIV. Maintenance                       | 32 |

## I. Overview

UT219P is a digital power clamp with fundamental frequency up to 1 kHz. This clamp meter can be used to measure AC voltage, AC current, active power, apparent power, reactive power, power factor, phase angle, power quality, frequency, phase sequence, total harmonic distortion, harmonic component, etc. It has different measurement modes including single phase, three-phase three-wire, and three-phase four-wire. Designed with Bluetooth function, measurement data can be monitored and recorded via mobile phone and tablet, and professional report can be generated. Featuring easy operation, stable performance, accurate measurement and more, UT219P can be applied in multiple fields such as:

- 1) Measure power quality of UPS to evaluate if operation is normal.
- 2) Measure power factor of power system to analyze capacitive or inductive load.
- 3) Measure harmonic of power grid of power system, to find out harmonic issue that may damage the load of nonlinear equipment of power grid.
- 4) Troubleshoot 400Hz AC power supply system of aviation and 25Hz AC power supply system of railway.
- 5) Test and maintain high-power motor, centrifugal fan, centrifugal water pump, wind power generation, solar power generation.
- 6) Test new energy vehicles and hybrid electric vehicles, evaluate motor efficiency, inverter efficiency and energy consumption of driving.

## II. Features

- 1) Completely sealed (Ip54).
- 2) Wide jaw opening (80mm) enables measuring current of thick conductor (Max. 75mm).
- 3) Category rating: CAT IV 600V AC, CAT III 1000V AC.
- 4) 1000V AC RMS voltage measurement, 15Hz~1000Hz frequency response range.
- 5) 1000A AC RMS current measurement, 15Hz~1000Hz frequency response range.
- 6) Ability to measure and display RMS and peak simultaneously.
- 7) Multiple wire connecting modes including single-phase two-wire, single-phase three-phase, balanced three-phase wire-wire, unbalanced three-phase three-wire, balanced three-phase four-wire, unbalanced three-phase four-wire, and more. Simple guidelines for wire connecting places can be shown on the upper and lower displays when performing three-phase connection.
- 8) Wide fundamental frequency range for power measurement: 15Hz~1000Hz.
- 9) Ability to analyze 40th voltage and current harmonics. THD %f (total harmonic to fundamental wave distortion), THD %r (total harmonic to full wave) and RMS of harmonic component of each order.
- 10) Identify if electricity theft occurs by comparing measurement of single-phase active electric energy of electric energy meter.
- 11) Detect phase sequence of motor to prevent inversed phase sequence of power supply from causing motor to rotate inversely.
- 12) Via Bluetooth APP, the product can record measurement data and generate graph, table, and report. The product has multiple functions including real-time monitoring for rapid troubleshooting, data recording and processing, integrated management, and more, so as to achieve integrated monitoring, maintenance and management.

### III. Accessories

Check the accessories in the package, if any of them is missing or damaged, please contact your supplier immediately.

|                                      |                  |
|--------------------------------------|------------------|
| User manual -----                    | 1 pc             |
| Test leads (red, black) -----        | 1 pair           |
| Alligator clips (red, black) -----   | 1 pair           |
| 1.5V AAA battery -----               | 3 pcs            |
| Tool box -----                       | 1 pc             |
| Brown box -----                      | 1 pc             |
| AAA Ni-MH rechargeable battery ----- | 3 pcs (optional) |
| Test probes (red, black) -----       | 1 pair           |











### IV. Safety Information

Note the "Warning labels and sentences". A Warning identifies conditions and procedures that are dangerous to the user and that can cause damage to the Product or the equipment under test.

The product is designed in accordance with IEC/EN61010-1, 61010-2-032, Electromagnetic Radiation EN61326-1 Standard, and conforms to Double Insulation, Overvoltage CAT III 1000V, CAT IV 600V and pollution degree 2. Failure to follow operating instructions can impair the protection provided by the product.

1. Check the product and test leads before use. Pay attention to any damage or abnormal situation. Please stop use if test lead and casing insulation are damaged, or the LCD displays nothing, or the product cannot work normally.
2. Before each use verify tester operation by measuring a known voltage.
3. It is forbidden to use without rear cover or battery cover set in place. Otherwise it may cause electric shock.
4. Keep fingers behind the finger guard and never make contact with exposed wire, connector input terminal not in use, or circuit being measured during measurement.
5. Do not exert AC voltage over 1000V between terminal and grounding to prevent electric shock and product damage.
6. Use caution when working with voltages over 60V DC or 30Vrms AC.
7. Never use the tester on a circuit with frequency that exceed the rating of this tester.
8. To meet the requirements of safety standard, please use the product together with equipped test leads and alligator clips. If test leads or alligator clips are damaged, replace a new one which should meet IEC61010-031 standard, rated follow parameters of the product or better.
9. When the symbol "  " appears on the LCD, please replace the battery in time to ensure measurement accuracy. Remove the battery if the product is not used for a long time.
10. Do not alter the internal wiring to avoid product damage and safety hazard.
11. Do not keep or use the product in environments with high temperature, high humidity, strong electromagnetic field, or inflammable and explosive environments.
12. Please wipe the casing with soft cloth and neutral cleaning agent, do not use abrasives or solvents, so as to avoid casing corrosion, product damage, and safety hazard.

### V. Electrical Symbols

| System  | Description   |
|---|---|
|  | Application around and removal from UNINSULATED HAZARDOUS LIVE conductors is permitted  |
|  | AC (Alternating Current)  |
|  | Bluetooth communication   |
|  | Double insulated  |
|  | Grounding   |
|  | Warning   |
|  | Conform to European Union standards   |
|  | Conform to UL STD 61010-1, 61010-2-032<br>Certified to CSA STD C22.2 NO. 61010-1, 61010-2-032   |
|  | UKCA certification mark   |
| <b>CAT III</b>  | Applicable to test and measure the circuit connected with the power distribution part of building's low-voltage MAINS installation.   |
| <b>CAT IV</b>   | Applicable to test and measure the circuit connected with the power supply of building's low-voltage MAINS installation.              |
|  | The product conforms to the identification requirement of WEEE directive.<br>Do not place equipment and its accessories in the trash. |

### VI. General Specifications

- 1) Overload protection voltage between input terminal and grounding: 1000V
- 2) Ingress protection: Ip54
- 3) Polarity indication: Auto
- 4) Overload indication: "OL" or "-OL"
- 5) Error caused by testing area: An additional error of  $\pm 1.0\%$  of reading can occur when the source to be measured is not placed at the center of the clamp jaws for current measurement.
- 6) Drop proof: 1 m
- 7) Maximum jaw opening: 80mm in diameter
- 8) Maximum diameter of measured conductor: 75 mm
- 9) Power supply: 3 X 1.5V AAA batteries (type: LR03) or 3 X 1.2V rechargeable Ni-MH batteries
- 10) Auto power off: The product powers off automatically after 15 minutes of inactivity.
- 11) Dimensions: 295 mm\*118mm\*50mm
- 12) Weight: About 630g (including battery)
- 13) Operating altitude: 2000 m
- 14) Intended use: Indoor user
- 15) Operating temperature and humidity: 0°C~30°C ( $\leq 80\%RH$ ); 30°C~40°C ( $\leq 75\%RH$ ); 40°C~50°C ( $\leq 45\%RH$ )
- 16) Storage temperature and humidity: -20°C~+60°C ( $\leq 80\%RH$ )
- 17) EMC: Under radio frequency field of 1V/m, overall accuracy = specified accuracy + 5% of range. Under radio frequency field over 1V/m, there is no specified specification.



VII. External Structure and Test Leads (Fig. 1)

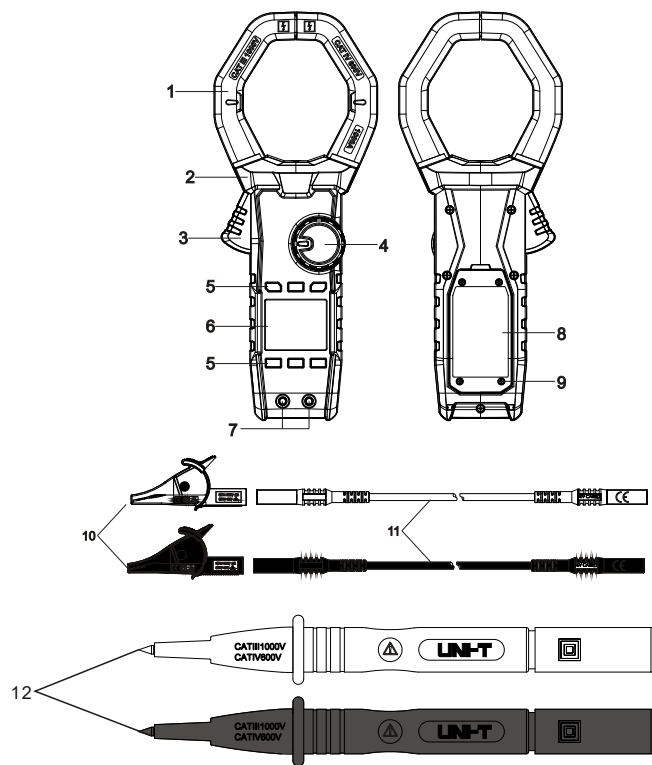

Fig. 1

1. Clamp jaw: A sensing device, used to measure AC current, can convert current to voltage.
2. Finger guard: Designed to protect user's finger from touching danger zone.
3. Trigger: Press to open jaws; release to close.
4. Rotary switch: Select function position
5. Functional buttons: Select basic functions
6. LCD display: Display measurement data and function symbols
7. Input terminals: Input voltage signal
8. Battery cover
9. Screws
10. Alligator clips: Conform to CAT III 1000V, CAT IV 600V
11. Test leads: Conform to CAT III 1000V, CAT IV 600V
12. Test probes

VIII. LCD Display (Fig. 2)

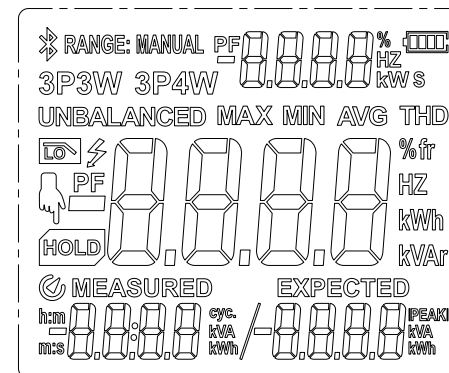

Fig. 2

- 1) Bluetooth communication symbol
- 2) RANGE: MANUAL: Manual current measurement mode
- 3) PF: Power factor
- 4) 3P3W: 3-phase 3-wire measurement mode
- 5) 3P4W: 3-phase 4-wire measurement mode
- 6) UNBALANCED: Unbalanced measurement mode
- 7) MAX: Maximum value measurement
- 8) MIN: Minimum value measurement
- 9) AVG: Average value measurement
- 10) THD %f: Total harmonic to fundamental distortion
- 11) THD %r: Total harmonic to full wave distortion
- 12) Flash symbol to indicate pressing HOLD button
- 13) HOLD: Data hold, or enter next operation with finger symbol
- 14) MEASURED: Actual measured accumulative electric energy
- 15) EXPECTED: Theoretical accumulative electric energy
- 16) Dangerous voltage
- 17) h : m: hour/minute
- 18) m : s: minute/second
- 19) cyc: Cyclic accumulative electric energy
- 20) PEAK: Peak measurement
- 21) V/A: Unit of voltage/current
- 22) Hz: Unit of frequency
- 23) kW: Unit of active power
- 24) kVA: Unit of apparent power
- 25) kVAr: Unit of reactive power
- 26) Wh, kWh: Unit of electric energy
- 27) Auto power off
- 28) Top right corner: Auxiliary display 1
- 29) Bottom left corner: Auxiliary display 2
- 30) Bottom right corner: Auxiliary display 3
- 31) Battery voltage

## IX. Rotary Switch (Fig. 3)

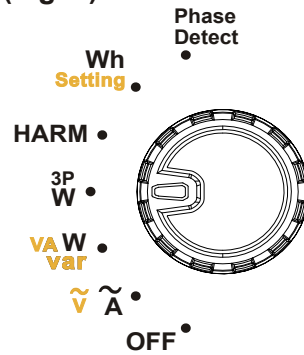

Fig. 3

| Position     | Description   |
|--------------|---|
| OFF          | Turn off the internal power supply of the product         |
| A/V          | AC current/voltage measurement                            |
| W/VA/var     | Single-phase power measurement                            |
| 3PW          | Three-phase power measurement                             |
| HARM         | Harmonic measurement                                      |
| Wh/Setting   | Electric energy/electric energy accumulation mode setting |
| Phase Detect | Phase sequence detection                                  |

## X. Button Descriptions

### 1. SELECT

- (1) A~/V~ position: Short press this button to cyclically select ACA → ACV on main display, the default position is ACA.
- (2) W/VA/var position: Short press this button to cyclically select active power → apparent power → reactive power → power factor → phase angle on main display, the default position is active power.
- (3) 3PW position: Under 3-phase 3-wire (3P3W, balanced) or 3-phase 4-wire (3P4W) mode, short press this button to cyclically select active power → apparent power → reactive power → power factor → phase angle on main display, the default position is active power. Under 3-phase 3-wire (3P3W) mode, short press this button to cyclically select phase-combined active power → P1 active power → P2 active power on main display the default display is phase-combined active power. Under 3-phase 4-wire (3P4W) mode, short press this button to cyclically select phase-combined active power → phase-combined apparent power → phase-combined reactive power → phase-combined phase angle → P1 active power → P2 active power → PC active power on main display, the default display is phase-combined active power.
- (4) HARM position: Short press this button to cyclically select voltage harmonic analysis → current harmonic analysis, the default position is current harmonic analysis.
- (5) Wh/Setting position: Short press this button to cyclically select single-phases electric energy → electric energy accumulation mode setting, the default position is single-phase electric energy.
- (6) Long press this button to turn on/off Bluetooth.

9

### 2. MAX/MIN

Short press this button to cyclically select real-time value → maximum value → minimum value → average value on the main display, and to record the time of capturing maximum and minimum values. Long press this button to exit maximum/minimum value measurement. The measurement is valid only under such modes including AC voltage, AC current, single-phase power, balanced three-phase power, etc.

### 3. RANGE

When this button is short pressed in auto range mode, the product enters manual mode, the LCD shows "RANGE: MANUAL", and the display is in current range. Press this button continuously to select AC current ranges cyclically. When this button is long pressed, the product exits manual range and enters auto range, "RANGE: MANUAL" does not appear on the LCD.

### 4. HOLD/

Under measurement interface (except unbalanced three phase, electric energy and phase sequence), short press this button to enter or exit data hold. When entering data hold mode, the LCD shows "HOLD"; when exiting data hold mode, the LCD does not show "HOLD".

Under the interface of switching wire connection, three-phase power enters its corresponding wire-connection measurement interface when this button is short pressed.

Under electric energy mode, short press this button to start or stop accumulative counting. Long press this button to turn on/off backlight. The backlight turns off automatically after it is turned on for one minute.

### 5. ▽/3P3W

For 3PW position, short press this button to select measurement mode of 3P3W balanced load and unbalanced load.

Under harmonic measurement mode, short press to adjust down the order of harmonic.

### 6. △/3P4W

For 3PW position, short press this button to select measurement mode of 3P4W balanced load and unbalanced load.

Under harmonic measurement mode, short press to adjust up the order of harmonic. Note: For the operating instructions of button of setting electric energy accumulation mode, please refer to the operating instructions of measurement in electric energy position.

## XI. Operating Instructions

Please check the three pieces of AAA batteries before measurement, if the battery voltage is low, the symbol "☐" will appear on the LCD, then please replace the battery in time. Note the symbol "⚠" around the terminal, this symbol warns that the measured voltage cannot exceed the specified voltage.

10

1. AC current measurement (Fig. 4)

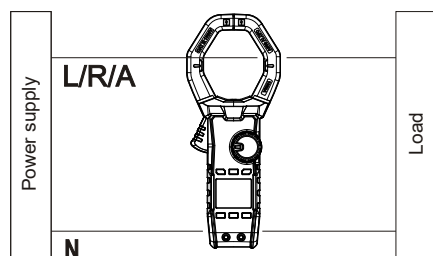

AC current measurement

Fig. 4

- 1) Set the rotary switch to "A~/V~", press SELECT to select AC current measurement. Press the trigger to clamp the measured conductor and then release the trigger slowly until the clamp jaws closes completely. Make sure that the measured conductor centers at the clamp jaws, error will be produced if the measured conductor does not centers at the clamp jaws. The clamp can only measure a current conductor at a time, if it measures two or more current conductors at the same time, the reading will be incorrect.
- 2) Read from the LCD the True RMS, peak and frequency of AC current, as shown below:

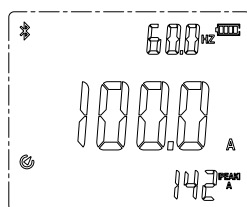

Note:

- Do not release the trigger abruptly when pressing and holding it. Hall sensor is sensitive to magnet, heat and mechanic stress, impact can cause reading variation in a short time.
- To ensure measurement accuracy, please place the measured conductor at the center of the clamp jaws. Error of ±1.0% of reading will be produced if the measured conductor is not placed at the center of the clamp jaws.

2. AC voltage measurement (Fig. 5)

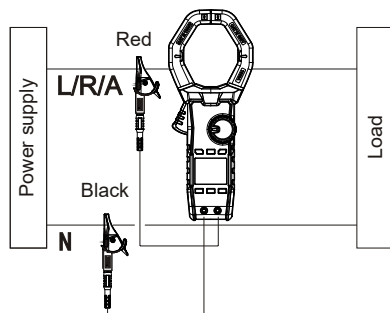

AC voltage measurement

Fig. 5

- 1) Connect red test lead (connected with red alligator clip already) with "V" terminal; and black (connected with black alligator clip already) with "COM".
- 2) Set the rotary switch to "A~/V~", press SELECT to select AC voltage measurement, and connect the alligator clips with power source or load to be measured in parallel.
- 3) Read from the LCD the True RMS, peak and frequency of AC voltage, as shown below:

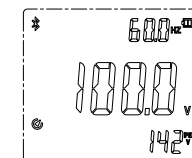

Note:

- Do not input voltage over 1000Vrms. It is possible to measure higher voltage, but it may damage the clamp.
- Avoid electric shock when working with high voltage.
- Disconnect test leads with the measured circuit after all measurement operations are completed.
- The high voltage warning symbol "⚡" will appear on the LCD if the measured voltage is over 30V AC; the red backlight flashes if the measured voltage is over 1000VAC.

3. WVA/var (Fig. 6 & Fig. 7)

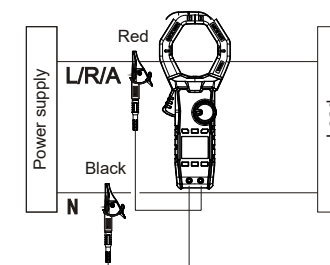

AC single-phase power measurement (1P2W)

Fig. 6

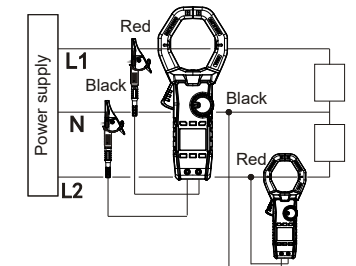

AC single-phase power measurement (1P3W)

Fig. 7

- 1) Connect red test lead (connected with red alligator clip already) with "V" terminal; and black (connected with black alligator clip already) with "COM".
- 2) Set the rotary switch to "W/VA/Var", connect alligator clips with power source and load to be measured, and clamp the conductor to be measured, the current flows from up to down (up: front; down: bottom cover), then release the trigger slowly until the clamp jaws close completely. Please make sure that the measured conductor centers at the clamp jaws, error will be produced

if the measured conductor is not placed at the center of the clamp jaws. The clamp can only measure a current conductor at a time, if it measures two or more current conductors at the same time, the reading will be incorrect.

3) Press SELECT to cyclically read active power, apparent power, reactive power, power factor, and phase angle, as shown below:

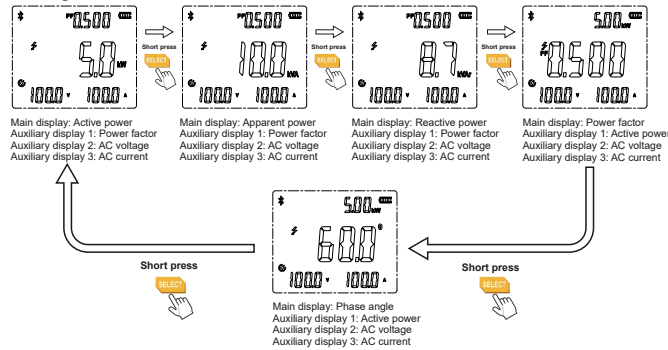

**Note:**

- Phase angle is in reference to voltage.
- Do not input voltage over 1000Vrms. It is possible to measure higher voltage, but it may damage the clamp.
- Avoid electric shock when working with high voltage.
- Disconnect test leads with the measured circuit after all measurement operations are completed.
- The high voltage warning symbol “⚡” will appear on the LCD if the measured voltage is over 30V AC; the red backlight flashes if the measured voltage is over 1000VAC.
- Do not release the trigger abruptly when pressing and holding it. Hall sensor is sensitive to magnet, heat and mechanic stress, impact can cause reading variation in a short time.
- To ensure measurement accuracy, please place the measured conductor at the center of the clamp jaws. Error of ±1.0% of reading will be produced if the measured conductor is not placed at the center of the clamp jaws.
- Incorrect wire connection will cause negative active power and cause the red backlight to flash, please check if the connections of voltage input terminal and clamp jaws are correct.

**4. 3-phase power measurement**

Wire connection interface:

The places of clamp jaws, black test lead and red test lead are shown in the figure below.

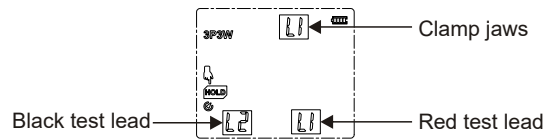

**4.1 3-phase 3-wire (3P3W) balanced mode (Fig. 8)**

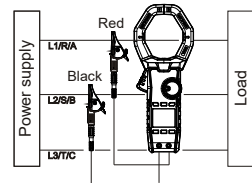

AC 3-phase 3-wire power measurement (3P3W balance)

Fig. 8

1) Connect red test lead (connected with red alligator clip already) with “V” terminal; and black (connected with black alligator clip already) with “COM”.

2) Set the rotary switch to “3PW”, press “∇/3P3W” to select 3P3W balance mode, then the clamp enters wire connection interface, as shown below:

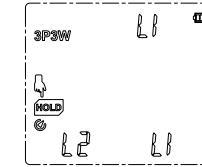

“L1” on top right corner indicates the jaws clamp L1 live wire, “L2” on bottom left corner indicates test lead from COM terminal connects with L2 live wire, “L1” on bottom right corner indicates test lead from V terminal connects with L1 live wire. The finger symbol on “HOLD” segment flashes to indicate pressing “HOLD” button to enter measurement interface.

3) According to the wire connection interface (Fig. 8), clamp L1 live wire, connect L1 live wire with test lead from V terminal, and connect L2 live wire with test lead from COM terminal, then press “HOLD” button to enter measurement interface.

4) In measurement interface, press SELECT button to cyclically read active power, apparent power, reactive power, power factor and phase angle, as shown below:

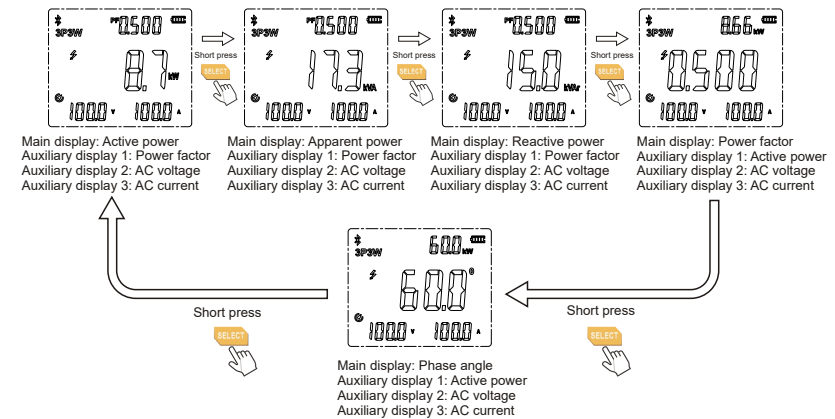

**4.2 3-phase 4-wire (3P4W) balance mode (Fig. 9)**

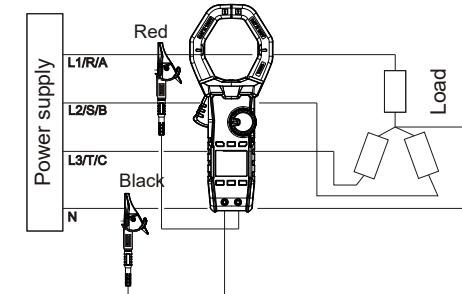

AC 3-phase 4-wire power measurement (3P4W balance)

Fig. 9

- 1) Connect red test lead (connected with red alligator clip already) with "V" terminal; and black (connected with black alligator clip already) with "COM".
- 2) Set the rotary switch to "3PW", press "Δ/3P4W" to select 3P4W balance mode, then the clamp enters wire connection interface, as shown below:

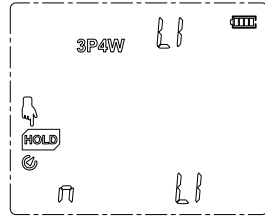

"L1" on top right corner indicates the jaws clamp L1 live wire, "n" on bottom left corner indicates test lead from COM terminal connects with neutral wire, "L1" on bottom right corner indicates test lead from V terminal connects with L1 live wire. The finger symbol on "HOLD" segment flashes to indicate pressing "HOLD" button to enter measurement interface.

- 3) According to the wire connection interface (Fig. 9), clamp L1 live wire, connect L1 live wire with test lead from V terminal, and connect neutral wire with test lead from COM terminal, then press "HOLD" button to enter measurement interface.
- 4) In measurement interface, press SELECT button to cyclically read active power, apparent power, reactive power, power factor and phase angle, as shown below:

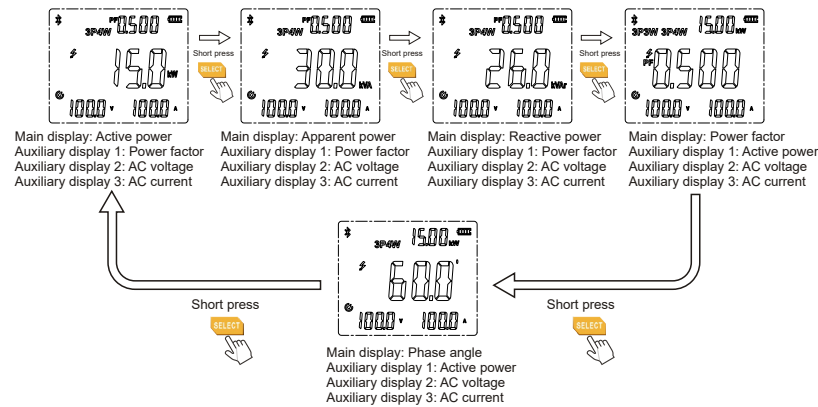

**4.3 3-phase 3-wire (3P3W) unbalance mode (Fig. 10)**

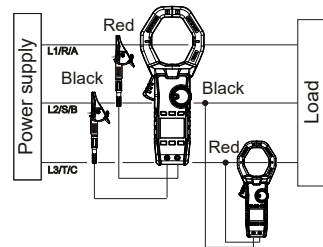

AC 3-phase 3-wire power measurement (3P3W unbalance)  
Fig. 10

- 1) Connect red test lead (connected with red alligator clip already) with "V" terminal; and black (connected with black alligator clip already) with "COM".
- 2) Set the rotary switch to "3PW", press "▽/3P3W" to select 3P3W unbalance mode, then the clamp enters P1 wire connection interface, as shown below:

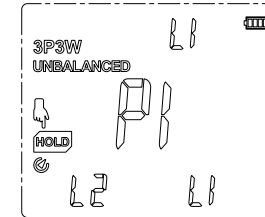

"L1" on top right corner indicates the jaws clamp L1 live wire, "L2" on bottom left corner indicates test lead from COM terminal connects with L2 live wire, "L1" on bottom right corner indicates test lead from V terminal connects with L1 live wire. The finger symbol on "HOLD" segment flashes to indicate pressing "HOLD" button to enter P1 measurement interface.

- 3) According to the wire connection interface (Fig. 10), clamp L1 live wire, connect L1 live wire with test lead from V terminal, and connect L2 live wire with test lead from COM terminal, then press "HOLD" button to enter P1 measurement interface, as shown below:

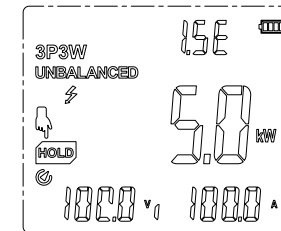

The finger symbol on "HOLD" segment flashes to indicate pressing "HOLD" button to enter P2 wire connection interface.

- 4) In P1 measurement interface, after the displayed value stabilizes, press "HOLD" button to enter P2 wire connection interface, as shown below:

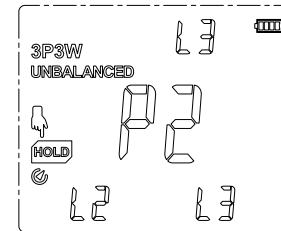

"L3" on top right corner indicates the jaws clamp L3 live wire, "L2" on bottom left corner indicates test lead from COM terminal connects with L2 live wire, "L3" on bottom right corner indicates test lead from V terminal connects with L3 live wire. The finger symbol on "HOLD" segment flashes to indicate pressing "HOLD" button to enter P2 measurement interface.

5) According to the wire connection interface (Fig. 10), clamp L3 live wire, connect L3 live wire with test lead from V terminal, and connect L2 live wire with test lead from COM terminal, then press "HOLD" button to enter P2 measurement interface, as shown below:

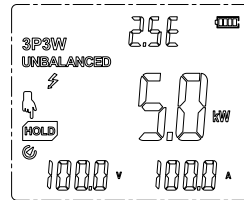

The finger symbol on "HOLD" segment flashes to indicate pressing "HOLD" button to enter phase-combined active power interface.

6) In P2 measurement interface, press "HOLD" button to read phase-combined active power, press SELECT button to cyclically read phase-combined active power, P1 active power and P2 active power, as shown below:

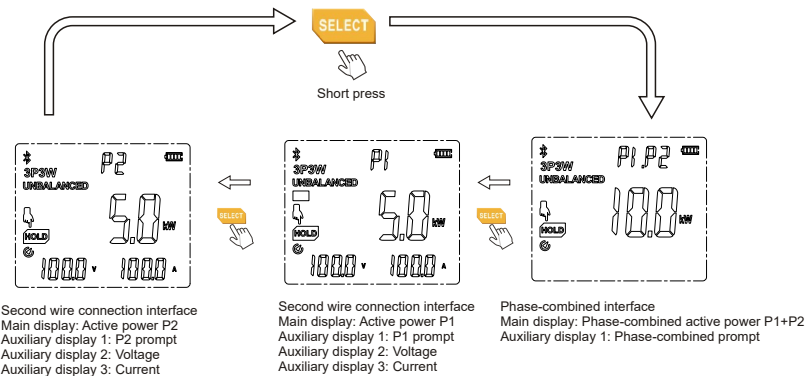

4.4 3-phase 4-wire (3P4W) unbalance mode (Fig. 11)

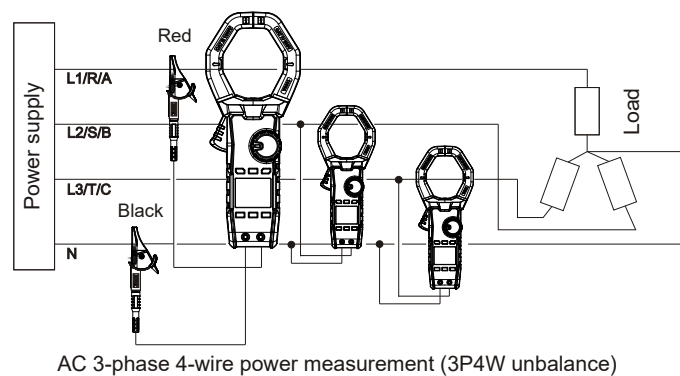
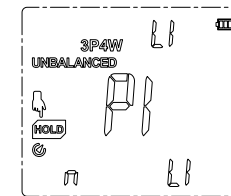

Fig. 11

1) Connect red test lead (connected with red alligator clip already) with "V" terminal; and black (connected with black alligator clip already) with "COM".

2) Set the rotary switch to "3PW", press "Δ/3P4W" to select 3P4W unbalance mode, then the clamp enters P1 wire connection interface, as shown below:



"L1" on top right corner indicates the jaws clamp L1 live wire, "n" on bottom left corner indicates test lead from COM terminal connects with neutral wire, "L1" on bottom right corner indicates test lead from V terminal connects with L1 live wire. The finger symbol on "HOLD" segment flashes to indicate pressing "HOLD" button to enter P1 measurement interface.

3) According to the wire connection interface (Fig. 11), clamp L1 live wire, connect L1 live wire with test lead from V terminal, and connect neutral wire with test lead from COM terminal, then press "HOLD" button to enter P1 measurement interface, as shown below:

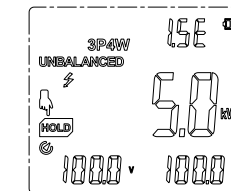

The finger symbol on "HOLD" segment flashes to indicate pressing "HOLD" button to enter P2 wire connection interface.

4) In P1 measurement interface, after the displayed value stabilizes, press "HOLD" button to enter P2 wire connection interface, as shown below:

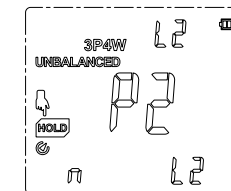

"L2" on top right corner indicates the jaws clamp L2 live wire, "n" on bottom left corner indicates test lead from COM terminal connects with neutral wire, "L2" on bottom right corner indicates test lead from V terminal connects with L2 live wire. The finger symbol on "HOLD" segment flashes to indicate pressing "HOLD" button to enter P2 measurement interface.



5) According to the wire connection interface (Fig. 11), clamp L2 live wire, connect L2 live wire with test lead from V terminal, and connect neutral wire with test lead from COM terminal, then press “HOLD” button to enter P2 measurement interface, as shown below:

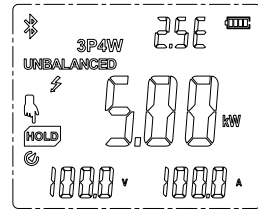

The finger symbol on “HOLD” segment flashes to indicate pressing “HOLD” button to enter P3 wire connection interface.

6) In P2 measurement interface, after the displayed value stabilizes, press “HOLD” button to enter P3 wire connection interface, as shown below:

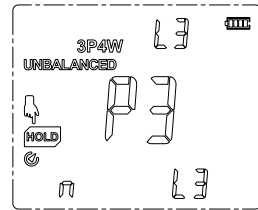

“L3” on top right corner indicates the jaws clamp L3 live wire, “n” on bottom left corner indicates test lead from COM terminal connects with neutral wire, “L3” on bottom right corner indicates test lead from V terminal connects with L3 live wire. The finger symbol on “HOLD” segment flashes to indicate pressing “HOLD” button to enter P3 measurement interface.

7) According to the wire connection interface (Fig. 11), clamp L3 live wire, connect L3 live wire with test lead from V terminal, and connect neutral wire with test lead from COM terminal, then press “HOLD” button to enter P3 measurement interface, as shown below:

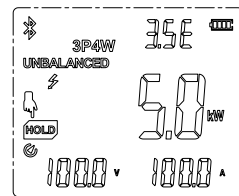

The finger symbol on “HOLD” segment flashes to indicate pressing “HOLD” button to enter phase-combined active power interface.

8) In P2 measurement interface, press “HOLD” button to read phase-combined active power, press SELECT button to cyclically read phase-combined active power, phase-combined apparent power, phase-combined reactive power, phase-combined phase angle, P1 active power, P2 active power and P3 active power, as shown below:

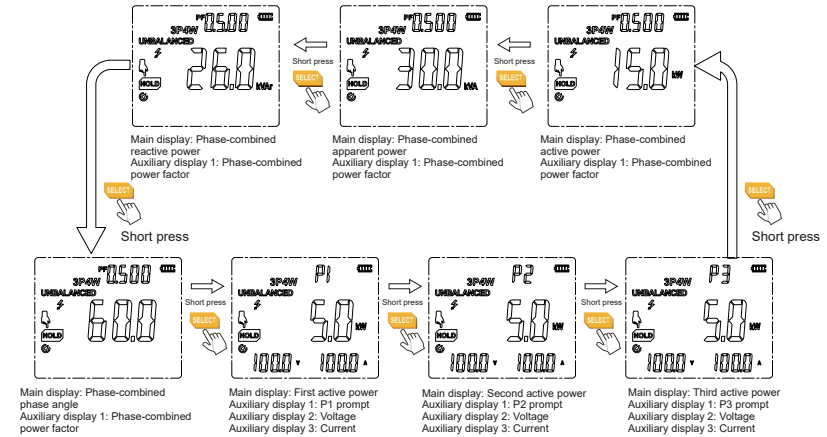

**Note:**

- Phase angle is in reference to voltage.
- Do not input voltage over 1000V. It is possible to measure higher voltage, but it may damage the clamp.
- Avoid electric shock when working with high voltage.
- Disconnect test leads with the measured circuit after all measurement operations are completed.
- The high voltage warning symbol “⚡” will appear on the LCD if the measured voltage is over 30V AC; the red backlight flashes if the measured voltage is over 1000VAC.
- Do not release the trigger abruptly when pressing and holding it. Hall sensor is sensitive to magnet, heat and mechanic stress, impact can cause reading variation in a short time.
- To ensure measurement accuracy, please place the measured conductor at the center of the clamp jaws. Error of ±1.0% of reading will be produced if the measured conductor is not placed at the center of the clamp jaws.
- Incorrect wire connection will cause negative active power and cause the red backlight to flash, please check if the connections of voltage input terminal and clamp jaws are correct.

**5. Harmonic analysis**

**5.1 Current harmonic analysis (Fig. 4)**

- 1) Set the rotary switch to “HARM”, press SELECT button to select AC current harmonic analysis. Press the trigger to clamp the measured conductor and then release the trigger slowly until the clamp jaws closes completely. Make sure that the measured conductor centers at the clamp jaws, error will be produced if the measured conductor does not centers at the clamp jaws. The clamp can only measure a current conductor at a time, if it measures two or more current conductors at the same time, the reading will be incorrect.
- 2) Press “Δ” or “▽” to read THD %f, THD %r, RMS of harmonic component of each order, and harmonic ratio of harmonic component of each order to fundamental wave, for examples:

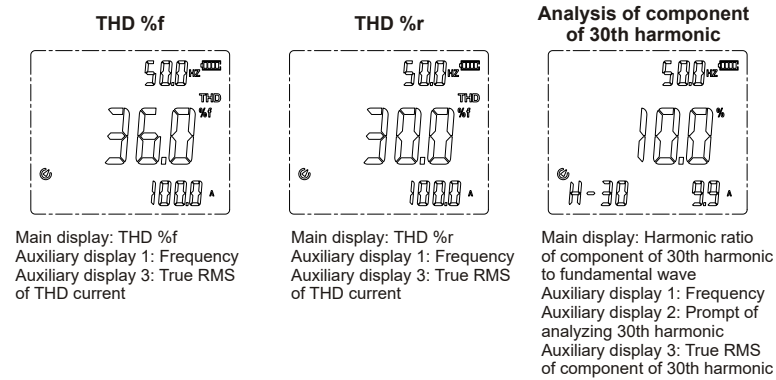

5.2 Voltage harmonic analysis (Fig. 5)

- 1) Connect red test lead (connected with red alligator clip already) with "V" terminal; and black (connected with black alligator clip already) with "COM".
- 2) Set the rotary switch to "HARM", press SELECT button to select AC voltage harmonic analyzing, then connect alligator clips with power source or load to be measured in parallel.
- 3) Press "Δ" or "∇" to read THD %f, THD %r, RMS of harmonic component of each order, and harmonic ratio of harmonic component of each order to fundamental wave, for examples:

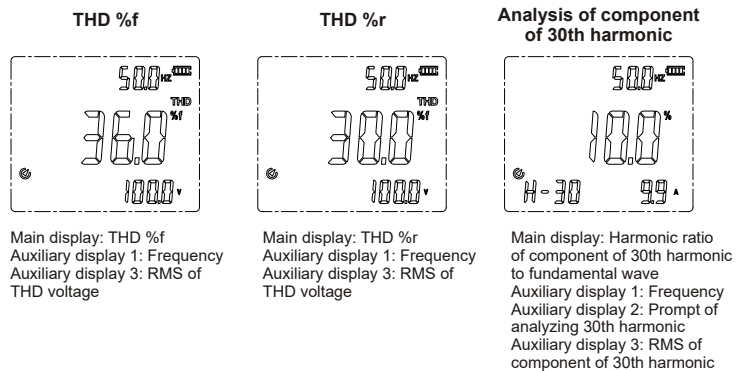

Note:

- Do not input voltage over 1000V. It is possible to measure higher voltage, but it may damage the clamp.
- Avoid electric shock when working with high voltage.
- Disconnect test leads with the measured circuit after all measurement operations are completed.
- The high voltage warning symbol "⚡" will appear on the LCD if the measured voltage is over 30V AC; the red backlight flashes if the measured voltage is over 1000VAC.
- Do not release the trigger abruptly when pressing and holding it. Hall sensor is sensitive to magnet, heat and mechanic stress, impact can cause reading variation in a short time.
- To ensure measurement accuracy, please place the measured conductor at the center of the clamp jaws. Error of ±1.0% of reading will be produced if the measured conductor is not placed at the center of the clamp jaws.
- If zero crossing of harmonic does not meet the zero-crossing condition of fundamental wave signal for multiple times, harmonic analysis can be performed by using the mode of setting fixed frequency.

6. Set the mode of electric energy accumulation (Fig. 12)

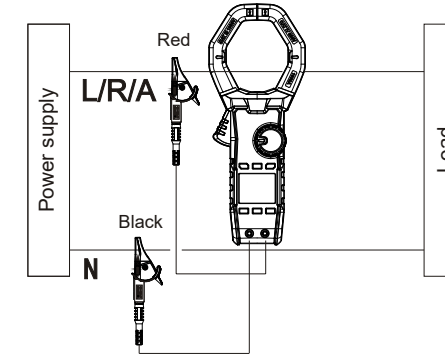

Single-phase active electric energy measurement

Fig. 12

- 1) Set the rotary switch to "Wh/Setting", press SELECT button to select the mode of electric energy accumulation, the setting parameters are shown as below:

| Serial No. | Setting value                | Change the setting value<br>Yes: √<br>No: — | Serial No. | Setting value | Change the setting value<br>Yes: √<br>No: — |
|------------|------------------------------|---|------------|---------------|---|
| oFF        | No value (time accumulation) | —   | 07         | 300 cyc./1kWh | √   |
| 01         | 3200 cyc./1kWh               | √   | 08         | 250 cyc./1kWh | √   |
| 02         | 1600 cyc./1kWh               | √   | 09         | 150 cyc./1kWh | √   |
| 03         | 1200 cyc./1kWh               | √   | 10         | 125 cyc./1kWh | √   |
| 04         | 1000 cyc./1kWh               | √   | 0.10kWh    | 0.10kWh       | —   |
| 05         | 600 cyc./1kWh                | √   | 0.05kWh    | 0.05kWh       | —   |
| 06         | 500 cyc./1kWh                | √   | 0.01kWh    | 0.01kWh       | —   |

Press "∇" or "Δ" to change the serial No. of main display. When the setting value can be changed by selecting serial No., press "HOLD" to select the part to be changed (auxiliary 2, auxiliary 3), then press "MAX MIN" to select ones place, tens place, hundreds place and thousands place of the value in auxiliary display 2. Press "∇" or "Δ" to change partial values. After the setting is changed, press "SELECT" to enter the mode of measuring electric energy accumulation.

Note: The changed setting will be saved in the clamp.

- 2) Connect alligator clips with power source or load to be measured in parallel, and clamp the conductor to be measured, the current flow from up to down (up: front; down: bottom cover), then release the trigger slowly until the clamp jaws close completely. Please make sure that the measured conductor centers at the clamp jaws, error will be produced if the measured conductor is not placed at the center of the clamp jaws. The clamp can only measure a current conductor at a time, if it measures two or more current conductors at the same time, the reading will be incorrect.

- 3) In measurement interface of electric energy accumulation, press "HOLD" to start or stop accumulating electric energy.

- Measurement interface of time accumulation of electric energy (Serial No.: OFF)



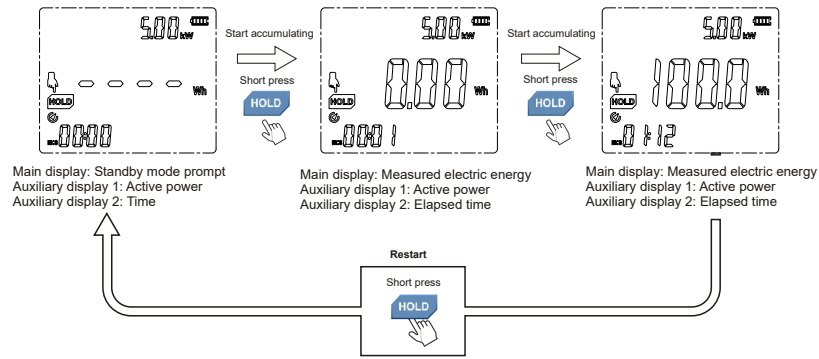

● Measurement interface of compare function of electric meter

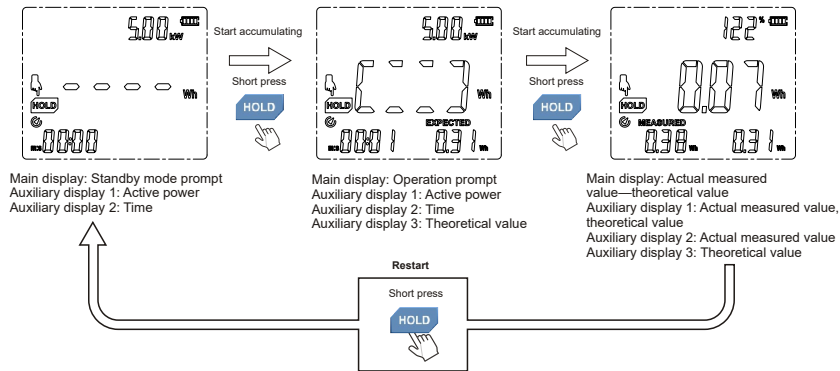

● Operate the compare function of electric meter

For comparing mechanical meter: Press “Hold” to start accumulation when the round disk rotates for one round; press “HOLD” again to stop accumulation when the round disk rotates for another round, as shown below:

**Mechanical Meter**  
Round disc rotates for one round

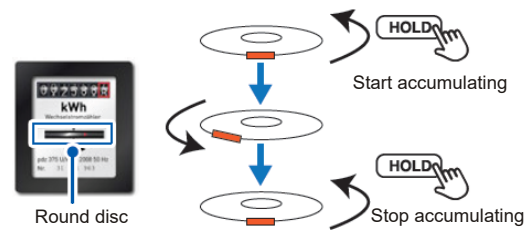

For comparing electronic meter: Press “Hold” to start accumulation when the LED flashes for one time, press “HOLD” again to stop accumulation when the LED flashes again, as shown below:

**Electronic Meter**  
LED flashes for one time

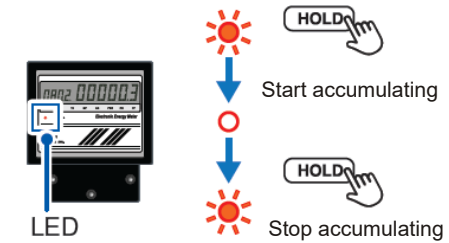

For comparing fixed electric energy meter: Take 0.1kWh as an example, press “HOLD” to start accumulation when the value changes by 0.1kWh; press “HOLD” again to stop accumulation when the value changes by 0.1kWh again, as shown below:



**Note:**

- Phase angle is in reference to voltage.
- Do not input voltage over 1000V. It is possible to measure higher voltage, but it may damage the clamp.
- Avoid electric shock when working with high voltage.
- Disconnect test leads with the measured circuit after all measurement operations are completed.
- The high voltage warning symbol “⚡” will appear on the LCD if the measured voltage is over 30V AC; the red backlight flashes if the measured voltage is over 1000VAC.
- Do not release the trigger abruptly when pressing and holding it. Hall sensor is sensitive to magnet, heat and mechanic stress, impact can cause reading variation in a short time.
- To ensure measurement accuracy, please place the measured conductor at the center of the clamp jaws. Error of ±1.0% of reading will be produced if the measured conductor is not placed at the center of the clamp jaws.
- Incorrect wire connection will cause negative active power and cause the red backlight to flash, please check if the connections of voltage input terminal and clamp jaws are correct.

7. Phase sequence detection (Fig. 13)

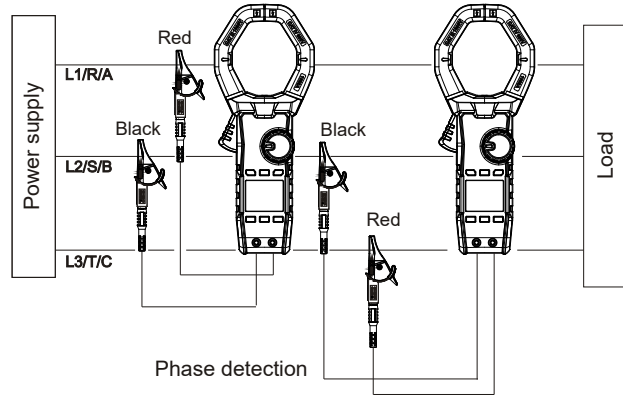
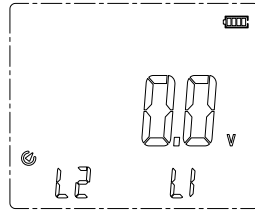

Fig. 13

- 1) Connect red test lead (connected with red alligator clip already) with "V" terminal; and black (connected with black alligator clip already) with "COM".
- 2) Set the rotary switch to "Phase Detect" to enter the first prompt interface of wire connection, as shown below:



"L2" on bottom left corner indicates test lead from COM terminal connects with L2 live wire, "L1" bottom right corner indicates test lead from V terminal connects with L1 live wire.

- 3) According to the first prompt interface of wire connection (Fig. 13), connect test lead from V terminal with L1 live wire, then connect test lead from COM terminal with L2 live wire. When the voltage is locked, the clamp enters the second prompt interface of wire connection, as shown below:

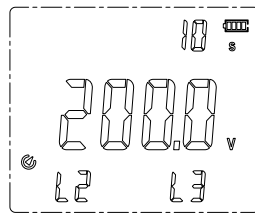

"L2" on bottom left corner indicates test lead from COM terminal connects with L2 live wire, "L3" bottom right corner indicates test lead from V terminal connects with L3 live wire, then the prompt time "10s" on top right corner starts to decrease.

- 4) According to the second prompt interface of wire connection (Fig. 13), within 10 seconds, connect test lead from V terminal with L3 live wire, and connect test lead from COM terminal with L2 live wire, then three kinds of testing results will be displayed.

- For positive sequence, "L1", "L2" and "L3" light up clockwise, as shown below:

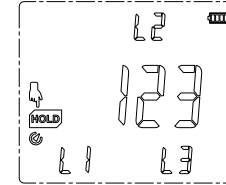

- For inverse sequence, "L1", "L2" and "L3" light up counterclockwise, and red backlight appears, as shown below:

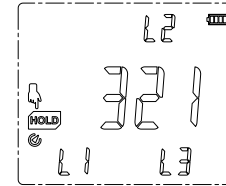

Note:

- Do not input voltage over 1000Vrms. It is possible to measure higher voltage, but it may damage the clamp.
- Avoid electric shock when working with high voltage.
- Disconnect test leads with the measured circuit after all measurement operations are completed.
- The high voltage warning symbol "⚡" will appear on the LCD if the measured voltage is over 30V AC; the red backlight flashes if the measured voltage is over 1000VAC.

- 5) Press "HOLD" to return to initial interface to start phase sequence detection.

8. Other functions

- Auto power off:

The clamp powers off automatically after 15 minutes of inactivity. To awaken the clamp, please press SELECT button in Auto-off state. To disable the Auto-off function, please hold down SELECT button and power on the clamp. Restart the clamp to enable the Auto-off function.

- Battery voltage detection:

When the battery voltage is:

- >3.6V, "██████" appears.
- 3.4V~3.6V, "██████" appears.
- 3.2V~3.4V, "██████" appears.
- 3.0V~3.2V, "██████" appears.
- 2.8V~3.0V, "██████" appears.
- <2.8V, the clamp powers off automatically.

- Red backlight as warning indication:  
Incorrect wire connection will cause negative active power and cause the red backlight to flash. The red backlight flashes when the measured voltage is >1000VAC and current >1000A. The red backlight flashes if the phase sequence is inverse.
- Analyzing fixed-frequency harmonic:  
Long press RANGE button to power on the clamp to HARM position, then the clamp enters the fixed-frequency harmonic setting interface, as shown below:

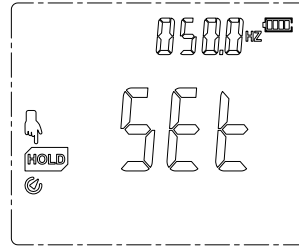

Press "MAX MIN" to select ones place, tens place, hundreds place and thousands place of the value in auxiliary display. Press "▽" or "△" to change partial values.

When "HOLD" is pressed after the setting is completed, the clamp enters fixed-frequency harmonic analysis mode, "SET" in auxiliary display and fixed frequency are displayed alternately for one second, as shown below, other displayed values are same with harmonic sweeping analysis mode.

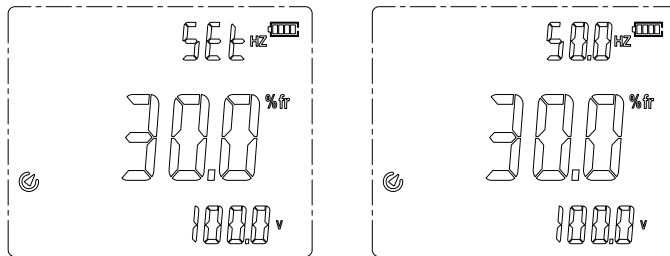

To reset fixed-frequency mode of other frequencies, please switch to other positions and then return to HARM position.

Note: Other positions are also in fixed-frequency mode.

## XII. Technical Specifications

Accuracy: ± (a% of reading + b digits), one-year warranty period  
Ambient temperature: 23°C±5°C (73.4°F±9°F); relative humidity: ≤75%

### Note:

The temperature condition of accuracy is 18°C~28°C, the fluctuation range of ambient temperature keeps within ±1°C. If the temperature is <18°C or >28°C, the additional error of temperature coefficient is "0.1 × (specified accuracy)/°C".

To ensure measurement accuracy, please place the measured conductor at the center of the clamp jaws. Error of ±1.0% of reading will be produced if the measured conductor is not placed at the center of the clamp jaws.

## 1. AC current

| Range  | Resolution | Accuracy  |           |             | Overload protection |
|--------|------------|-----------|-----------|-------------|---------------------|
|        |            | 15Hz~40Hz | 40Hz~70Hz | 70Hz~1000Hz |                     |
| 60.00A | 0.01A      | ±(2.5%+5) | ±(2.0%+3) | ±(2.5%+5)   | 1000A AC            |
| 600.0A | 0.1A       |           | ±(1.5%+3) |             |                     |
| 1000A  | 1A         |           |           |             |                     |

- ACA frequency response: 15~1kHz
- ACA displayed true RMS, measurement range:  
60.00A range: 0.30A~62.00A  
600.0A range: 3A~620.00A  
1000A range: 30A~1100A
- Range to ensure accuracy: 5~100% of Range
- PEAK measurement range:  
60.00A range: 0.3A~120.0A  
600.0A range: 3A~1200A  
1000A range: 30A~1500A
- PEAK accuracy:  
60A position:  
40Hz~70Hz: ±(5.0%+15)  
70Hz~1kHz: ±(6.5%+15)  
600A/1000A position:  
40Hz~70Hz: ±(5.0%+5)  
70Hz~1kHz: ±(6.5%+5)
- PEAK coefficient: <2.0

## 2. AC voltage

| Range | Resolution | Accuracy  |           |             | Overload protection |
|-------|------------|-----------|-----------|-------------|---------------------|
|       |            | 15Hz~40Hz | 40Hz~70Hz | 70Hz~1000Hz |                     |
| 999.9 | 0.1V       | ±(2.0%+5) | ±(0.7%+3) | ±(2.0%+5)   | 1000Vrms            |

- ACV input impedance: ≥2MΩ
- ACV frequency response: 15~1kHz
- ACV displayed true RMS, measurement range: 30.0V~999.9V
- PEAK measurement range: ± (30.0V~1500V)
- PEAK accuracy:  
40Hz~70Hz: ±(2.5%+5)  
15Hz~40Hz; 70~1000Hz: ±(4.0%+5)
- PEAK coefficient: <1.5

## 3. Power

### 3.1 Active power

| Range   | Resolution | Accuracy  |           |             | Overload protection |
|---------|------------|-----------|-----------|-------------|---------------------|
|         |            | 15Hz~40Hz | 40Hz~70Hz | 70Hz~1000Hz |                     |
| 60.00kW | 0.01kW     | ±(2.5%+5) | ±(2.0%+5) | ±(2.5%+5)   | 1000AAC<br>1000Vrms |
| 600.0kW | 0.1kW      |           | ±(1.7%+5) |             |                     |
| 1000kW  | 1kW        |           |           |             |                     |

**Note:**

- 1) If the displayed power factor is not 1, please calculate the specification of power according to the phase angle error.
- 2) [1P] 0.09kW~1000kW
- 3) [3P3W] 0.15kW~1732kW
- 4) [3P4W] 0.27kW~3000kW

**3.2 Apparent power**

| Range    | Resolution | Accuracy                     |                              |                                | Overload protection  |
|----------|------------|------------------------------|------------------------------|--------------------------------|----------------------|
|          |            | 15Hz~40Hz<br>Power factor: 1 | 40Hz~70Hz<br>Power factor: 1 | 70Hz~1000Hz<br>Power factor: 1 |                      |
| 60.00kVA | 0.01kVA    | ±(2.5%+5)                    | ±(2.0%+5)                    | ±(2.5%+5)                      | 1000A AC<br>1000Vrms |
| 600.0kVA | 0.1kVA     |                              | ±(1.7%+5)                    |                                |                      |
| 1000kVA  | 1kVA       |                              |                              |                                |                      |

**Note:**

- 1) If the displayed power factor is not 1, please calculate the specification of power according to the phase angle error.
- 2) [1P] 0.09kVA~1000kVA
- 3) [3P3W] 0.15kVA~1732kVA
- 4) [3P4W] 0.27kVA~3000kVA

**3.3 Reactive power**

| Range    | Resolution | Accuracy                     |                              |                                | Overload protection  |
|----------|------------|------------------------------|------------------------------|--------------------------------|----------------------|
|          |            | 15Hz~40Hz<br>Power factor: 1 | 40Hz~70Hz<br>Power factor: 1 | 70Hz~1000Hz<br>Power factor: 1 |                      |
| 60.00kVA | 0.01kVA    | ±(3.0%+5)                    | ±(2.5%+5)                    | ±(3.0%+5)                      | 1000A AC<br>1000Vrms |
| 600.0kVA | 0.1kVA     |                              | ±(2.0%+5)                    |                                |                      |
| 1000kVA  | 1kVA       |                              |                              |                                |                      |

**Note:**

- 1) If the displayed power factor is not 1, please calculate the specification of power according to the phase angle error.
- 2) [1P] 0.09kVA~1000kVA
- 3) [3P3W] 0.15kVA~1732kVA
- 4) [3P4W] 0.27kVA~3000kVA

**3.4 Power factor**

| Range | Resolution | Accuracy   | Overload protection  | Remark   |
|-------|------------|--|----------------------|--|
|       |            | 15Hz~1000Hz  |                      |  |
| -1~1  | 0.001      | Calculate the specification of power factor according to the phase angle error | 1000A AC<br>1000Vrms | Min. measured voltage: 30V<br>Max. measured current: 10A |

**3.5 Phase angle**

| Range                              | Resolution | Accuracy  |           |             | Overload protection  | Remark   |
|------------------------------------|------------|-----------|-----------|-------------|----------------------|--|
|                                    |            | 15Hz~40Hz | 40Hz~70Hz | 70Hz~1000Hz |                      |  |
| -180° (advance)<br>~179.9° (delay) | 0.1°       | ±5°       | ±3°       | ±5°         | 1000A AC<br>1000Vrms | Min. measured voltage: 30V<br>Max. measured current: 10A |

**Note:**

1. The null-position cross phase difference between current and voltage waveforms is positive if current lags behind voltage; negative if current is ahead of voltage.
2. An error of 2° is added if the measured conductor is not placed at the center of the clamp jaws.

**4. Harmonic analysis**

| Function                      | Harmonic order | Accuracy    | Overload protection  |
|-------------------------------|----------------|-------------|----------------------|
|                               |                | 15Hz~400Hz  |                      |
| RMS of harmonic of each order | 1              | ±(3.0%+10)  | 1000A AC<br>1000Vrms |
|                               | 2 6            | ±(3.5%+10)  |                      |
|                               | 7 8            | ±(4.5%+10)  |                      |
|                               | 9 10           | ±(5.0%+10)  |                      |
|                               | 11 15          | ±(7.0%+10)  |                      |
|                               | 16 30          | ±(10.0%+10) |                      |
|                               | 30 40          | ±(20.0%+10) |                      |

**Note:**

- 1) Minimum measured voltage is 30V, minimum measured current: >10% of current range.
- 2) THD-F and THD-R are displayed on the LCD.
- 3) Harmonic analysis is recorded in the clamp, and can be displayed and viewed on mobile APP via Bluetooth module.
- 4) If fundamental frequency is 100Hz, the harmonic order reaches 40.  
If fundamental frequency is >100Hz, the harmonic order reaches 15.

**5. Frequency**

| Range       | Resolution | Accuracy    | Overload protection  |
|-------------|------------|-------------|----------------------|
|             |            | 15Hz~1000Hz |                      |
| 15Hz 1000Hz | 0.1Hz      | ±(0.3%+3)   | 1000A AC<br>1000Vrms |

**Note:**

Minimum measured voltage is 30V, minimum measured current: >5% of current range.

**6. Phase detection**

| Function     | Range     | Frequency | Overload protection |
|--------------|-----------|-----------|---------------------|
| Phase Detect | 80V~1000V | 40Hz~80Hz | 1000Vrms            |

**Note:**

The LCD shows "1 2 3" to indicate positive phase sequence or "3 2 1" to indicate negative one. The LCD shows "— — —" to indicate phase loss or unmeasurable.

## 7. Single-phase active electric energy

| Range            | Calculating method   | Overload protection  |
|------------------|--|----------------------|
| 0.00Wh~999.9k Wh | Every 0.3 second, add the step value of electric energy of last positive active power; add zero for negative active power. | 1000A AC<br>1000Vrms |

## XIII. Bluetooth software

### 1. Introduction

The Bluetooth software is a mobile APP, supporting mobile phones running iOS 10.0 or newer and Android 5.0 or newer. Mobile phones running other operating system depends on the actual issued application software.

### 2. Installation

For iOS: Search "UNI-T Smart Measurement" in "App Store".

For Android: Search "UNI-T Smart Measurement" on UNI-T official website or scan the QR code below.



(QR code for IOS)



(QR code for Android)

### 3. Usage

3.1. Long press "SELECT" to turn on Bluetooth, if the clamp fails to connect with the mobile APP after Bluetooth is turned on, the Bluetooth symbol on the LCD will flash. Click "UNI-T Smart Measurement" APP icon, select "UT219P", then click connection. User can also scan the QR code at the clamp for direct connection. After successful connection, the Bluetooth symbol is displayed on the LCD for a long time. Data communication, measurement result viewing, button control and other operations can be achieved through "UNI-T Smart Measurement" APP.

3.2. "UNI-T Smart Measurement" APP has multiple functions including Bluetooth communication, data recording, meter management, report generation, data share, data synchronization, and more. Please refer to "UNI-T Smart Measurement" User Manual for how to use the functions mentioned.

### 4. Uninstallation

To uninstall the APP, please use the uninstaller of mobile phone.

## XIV. Maintenance (Fig. 14)

### Warning:

#### 1. General maintenance

- The product must be maintained or serviced by qualified professional repair personnel or designated repair department.
- Clean the casing with dry cloth periodically, do not use cleaning agent containing abrasive or solvent.

#### 2. Battery installation or replacement

The product is powered by 3 AAA batteries, please install or replace the battery according to the steps below:

- Power off the product and remove the test leads from the input terminal.
- Loosen the screw, take off the battery cover, remove the battery, and then install new battery according to correct polarity.
- Please install appropriate battery with same model as original battery.
- Rejoin the battery cover and tighten the screw.

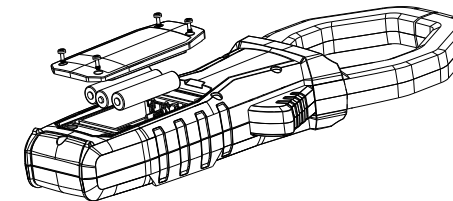

Fig. 14